



BROCHURE

---

ACCESSORIES FOR

# SLIDE & FOLD

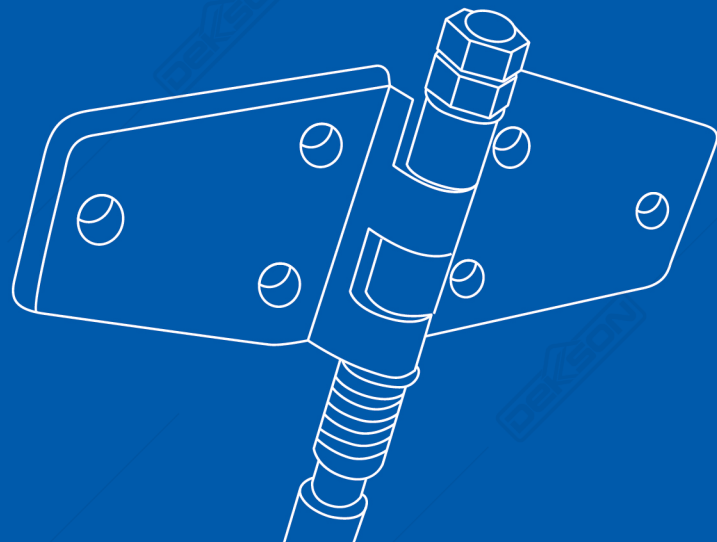
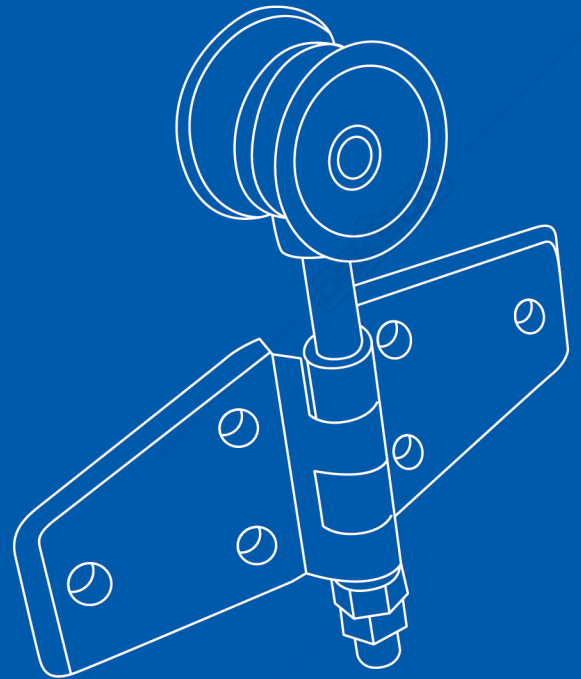
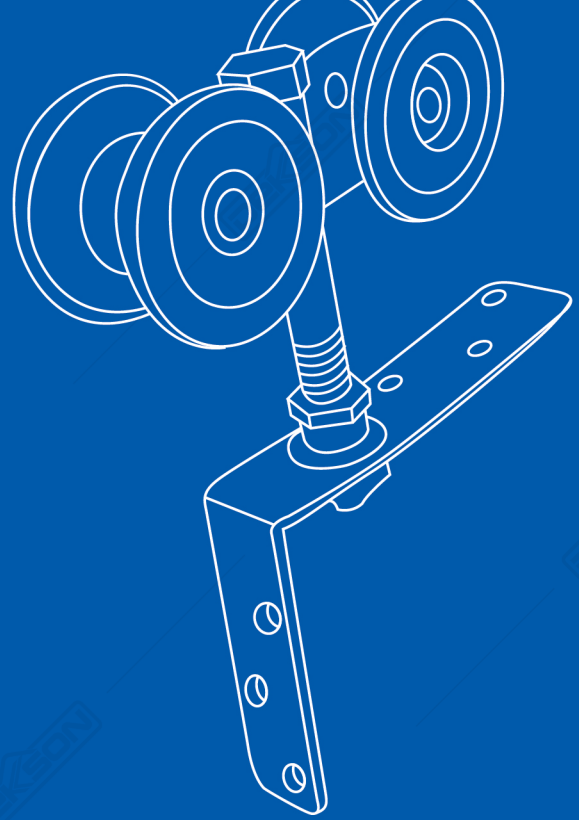



THE MODERN ACCESSORIES

# SLIDE & FOLD DOOR

Rangkaian aksesoris pintu dorong lipat berkualitas dari Dekkson yang terbukti dapat membantu memastikan pintu dorong lipat anda berfungsi secara optimal, sekaligus menjamin tingkat keamanan dan daya tahan yang tinggi. Selain itu, Dekkson juga menawarkan tipe aksesoris pintu dorong lipat yang beragam, sehingga anda dapat mewujudkan apapun jenis pintu dorong lipat yang anda idamkan.

# Table of Contents :

## ACCESSORIES FOR SLIDE & FOLD DOOR CONTENT (80 Kg)

### Pintu Dorong Lipat Eksterior Roda "STANDARD"

---

- Skema Pintu Dorong
- Gambar Tampak, Gambar Potongan, dan Gambar Denah

**03**

### Pintu Dorong Lipat Eksterior Roda "L"

---

- Skema Pintu Dorong
- Gambar Tampak, Gambar Potongan, dan Gambar Denah

**05**

### Pintu Dorong Menikung Eksterior Roda "STANDARD"

---

- Skema Pintu Dorong
- Gambar Tampak, Gambar Potongan, dan Gambar Denah

**07**

### Pintu Dorong Lipat Tengah Interior

---

- Skema Pintu Dorong
- Gambar Tampak, Gambar Potongan, dan Gambar Denah

**09**

### Pintu Dorong Lipat Pinggir Interior

---

- Skema Pintu Dorong
- Gambar Tampak, Gambar Potongan, dan Gambar Denah

**11**

### Indeks Aksesories Pintu Dorong Lipat

---

- Skema Pintu Dorong
- Gambar Tampak, Gambar Potongan, dan Gambar Denah

**13**

# PINTU DORONG LIPAT EKSTERIOR

RODA "STANDARD"



① RODA ATAS TENGAH



WH 9105 (57MM) GALV

② RODA ATAS PINGGIR



WH 9106 (57MM) GALV

③ ENGSEL TENGAH



HN 8306 (57MM) GALV

④ RODA BAWAH TENGAH



WH 8205 (57MM) GALV

⑤ RODA BAWAH PINGGIR



WH 8206 (57MM) GALV

⑥ ENGSEL KUPU - KUPU

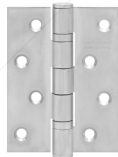

ESS EL 4X3X3MM 2BB SSS

⑦ GREDEL TANAM PLAT



FBP 8" SSS

⑧ GREDEL BAWAH BIASA

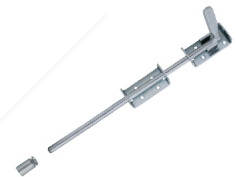

BB 9204 (38/57MM) GALV

⑨ REL ATAS



TR 9123 - 2.3M (57MM) GALV  
TR 9129 - 2.9M (57MM) GALV

⑩ REL BAWAH



TR 9224 - 2.4M (38/57MM) GALV  
TR 9230 - 3M (38/57MM) GALV

⑪ BREKET SAMPING



BR 9100 (57MM) GALV

⑫ PULL HANDLE



PH D855 19×195×152 SSS

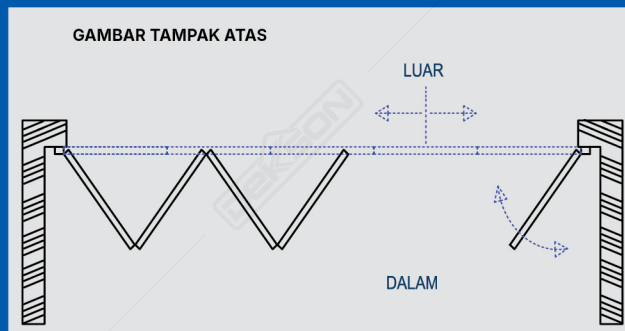
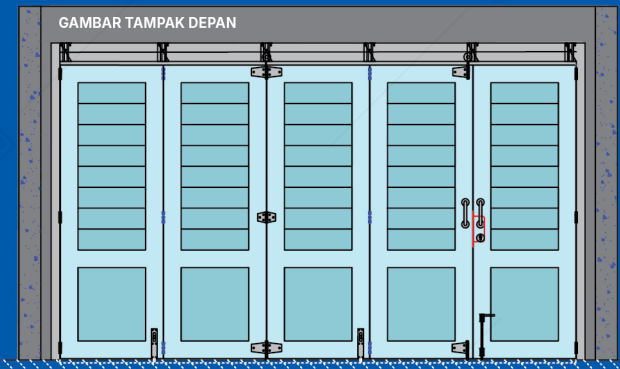

Gambar Potongan

13 MORTISE ROLLER



MTS RL DL 8585 SSS

14 DOUBLE CYLINDER



CYL DC DL 60 MM SN

15 ESCUTCHEON



ESCN 855 SSS

16 RODA ATAS TENGAH "RD4"  
Digunakan sebagai alternatif apabila maksimum berat daun pintu 100 kg



WH 8144 RD4 (57MM) GALV

17 BAUT BREKET & FISHER



BF 3/8x2,5" (38/57MM) GALV  
BF 3/8x3" (38/57MM) GALV

Spesifikasi

Maksimum tinggi pintu : 2400 mm  
Maksimum berat pintu : 80 kg/daun pintu  
Tebal pintu : 40 - 50 mm

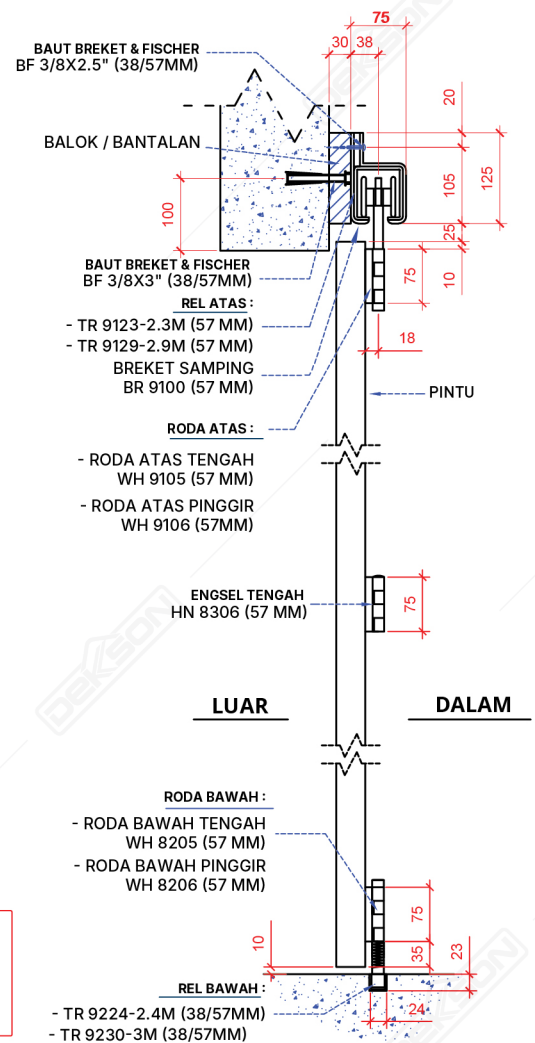

# PINTU DORONG LIPAT EKSTERIOR

RODA "RODA L"



① RODA ATAS TENGAH "L"



WH 8195-L (57MM)  
GALV

② ENGSEL TENGAH



HN 8306 (57MM)  
GALV

③ RODA BAWAH TENGAH



WH 8205 (57MM)  
GALV

④ ENGSEL KUPU - KUPU



ESS EL 4X3X3MM 2BB SSS

⑤ GRENDEL TANAM PLAT



FBP 8" SSS

⑥ GRENDEL BAWAH BIASA

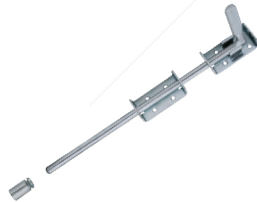

BB 9204 (38/57MM)  
GALV

⑦ REL ATAS



TR 9123 - 2.3M (57MM) GALV  
TR 9129 - 2.9M (57MM) GALV

⑧ REL BAWAH



TR 9224 - 2.4M (38/57MM) GALV  
TR 9230 - 3M (38/57MM) GALV

⑨ BREKET SAMPING



BR 9100 (57MM)  
GALV

⑩ PULL HANDLE



PH D855 19x195x152 SSS

⑪ MORTISE ROLLER



MTS RL DL 8585 SSS

⑫ DOUBLE CYLINDER



CYL DC DL 60 MM SN



GAMBAR TAMPAK DEPAN

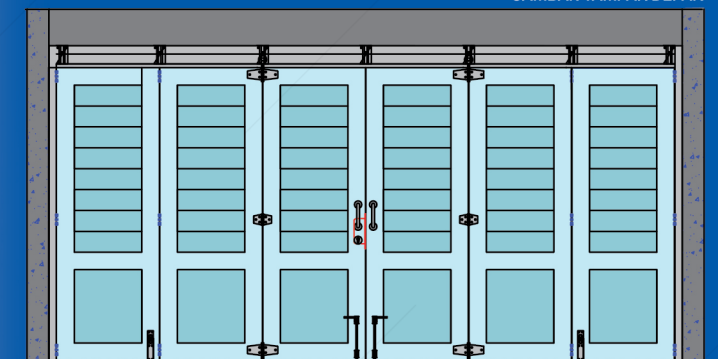

GAMBAR TAMPAK ATAS

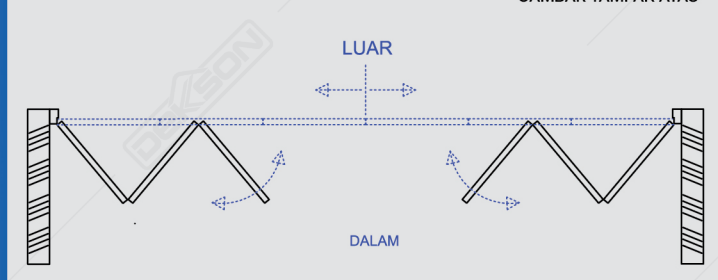

13 ESCUTCHEON



ESCN 855 SSS

14 RODA ATAS PINGGIR "L"



WH 8196-L (57MM)  
GALV

15 RODA BAWAH PINGGIR



WH 8206 (57 MM)

16 BAUT BREKET & FISHER



BF 3/8x2,5" (38/57MM) GALV  
BF 3/8x3" (38/57MM) GALV

Gambar Potongan

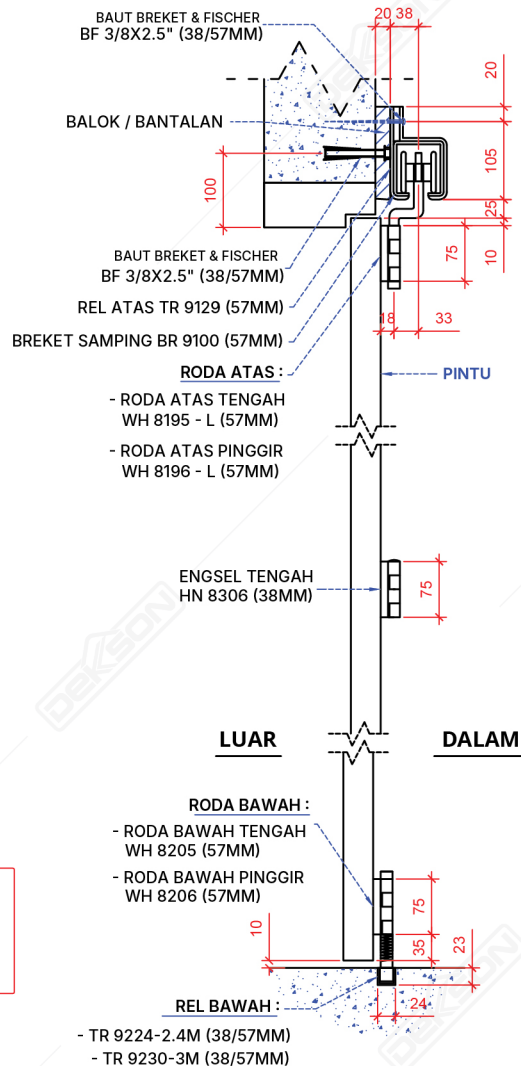

**Spesifikasi**

Maksimum tinggi pintu : 2400 mm  
Maksimum berat pintu : 80 kg/daun pintu  
Tebal pintu : 40 - 50 mm

# PINTU DORONG MENIKUNG EKSTERIOR

RODA "STANDARD"

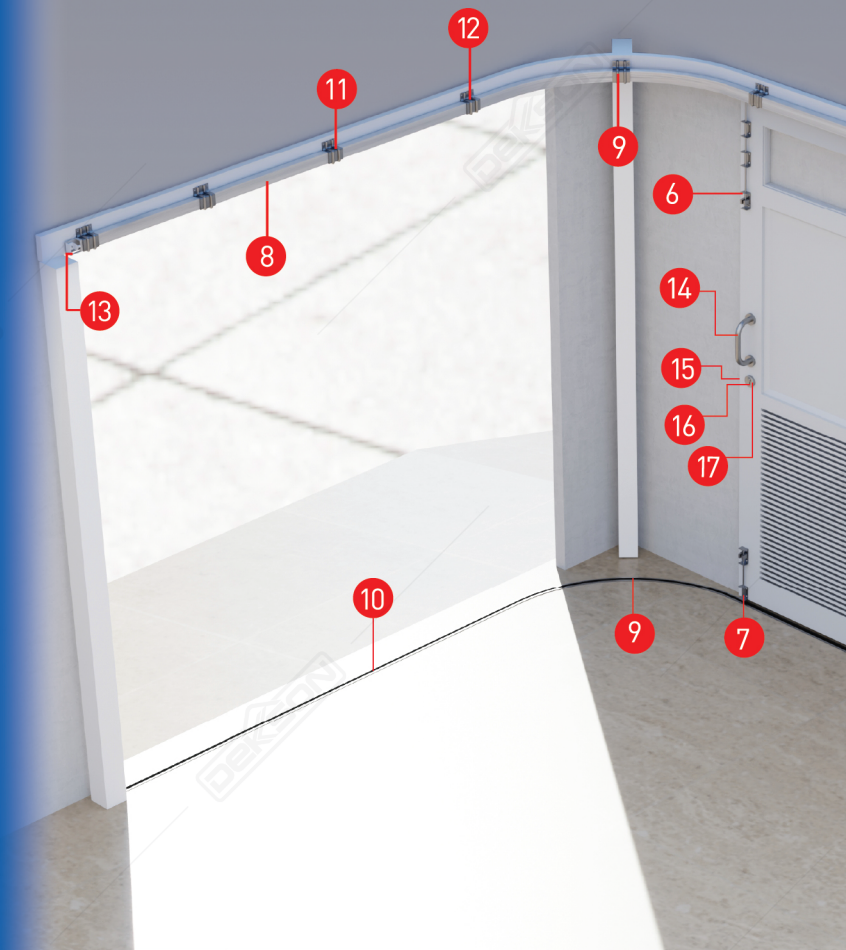

① RODA ATAS TENGAH



WH 9105 (57MM) GALV

② RODA ATAS PINGGIR



WH 9106 (57MM) GALV

③ ENGSEL TENGAH



HN 8306 (57MM) GALV

④ RODA BAWAH TENGAH



WH 8205 (57MM) GALV

⑤ RODA BAWAH PINGGIR



WH 8206 (57MM) GALV

⑥ GRENDEL ATAS



BB 8104-UK 75CM (38/57MM) GALV

⑦ GRENDEL BAWAH BERODA



BB 8204 (38/57MM) GALV

⑧ REL ATAS



TR 9123 - 2.3M (57MM) GALV  
TR 9129 - 2.9M (57MM) GALV

⑨ REL TIKUNG ATAS & BAWAH

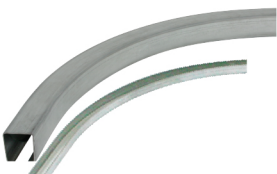

TR 9190 (57MM) GALV

⑩ REL BAWAH



TR 9224 - 2.4M (38/57MM) GALV  
TR 9230 - 3M (38/57MM) GALV

⑪ BREKET SAMPING



BR 9100 (57MM) GALV

⑫ BREKET SAMBUNG



BR 9101 (57MM) GALV

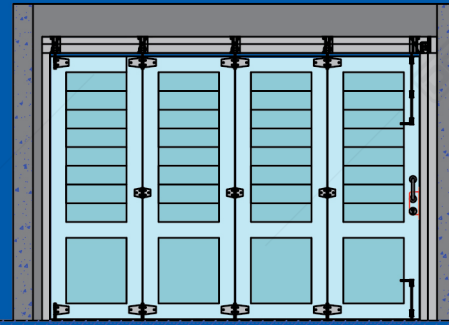

GAMBAR TAMPAK ATAS

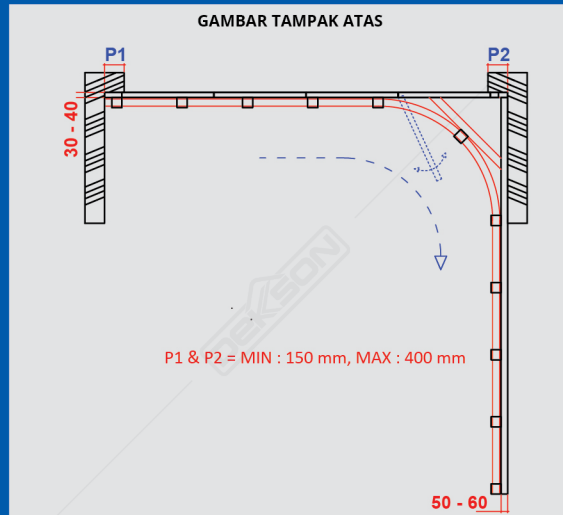

Gambar Potongan

13 TUTUP BREKET & STOPPER



BR 9102 (57MM)  
GALV

14 PULL HANDLE



PH D855 19×195×152 SSS

15 MORTISE SLIDING



MTS SLD DL 84100 N

16 DOUBLE CYLINDER



CYL DC DL 60 MM SN

17 ESCUTCHEON



ESCN 855 SSS

18 BAUT BREKET & FISHER



BF 3/8×2,5" (38/57MM) GALV  
BF 3/8×3" (38/57MM) GALV  
BF 3/8×4" (38/57MM) GALV

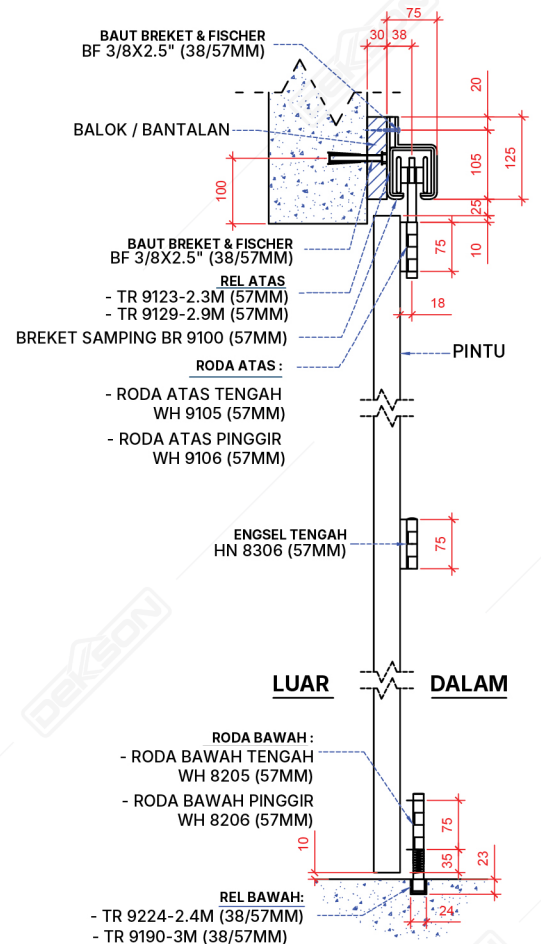

Spesifikasi

Maksimum tinggi pintu	: 2400 mm
Maksimum berat pintu	: 80 kg/daun pintu
Maksimum lebar pintu	: 820 mm
Tebal pintu	: 40 - 50 mm

# PINTU DORONG LIPAT TENGAH INTERIOR



① RODA ATAS LIPAT TENGAH



WH 7185 (57MM) GALV

② RODA ATAS LIPAT TENGAH "RD4"

Digunakan sebagai alternatif apabila maksimum berat daun pintu 100 kg



WH 7184 - RD4 (57MM) GALV

③ ENGSEL KUPU - KUPU



ESS EL 4X3X3MM 2BB SSS

④ GRENDEL TANAM PLAT



FBP 8" SSS

⑤ REL ATAS



TR 9123 - 2.3M (57MM) GALV  
TR 9129 - 2.9M (57MM) GALV

⑥ REL BAWAH



TR 9224 - 2.4M (38/57MM) GALV  
TR 9230 - 3M (38/57MM) GALV

⑦ BREKET GANTUNG



BR 9185 (57MM) GALV

⑧ PULL HANDLE



PH D855 19x195x152 SSS

⑨ MORTISE ROLLER



MTS RL DL 8585 SSS

⑩ DOUBLE CYLINDER



CYL DC DL 60 MM SN

⑪ ESCUTCHEON



ESCN 855 SSS

⑫ RODA BAWAH LIPAT TENGAH



WH 7285 (38/57MM) GALV

⑬ BAUT BREKET & FISHER



BF 3/8x2,5" (38/57MM) GALV  
BF 3/8x3" (38/57MM) GALV



Gambar Potongan

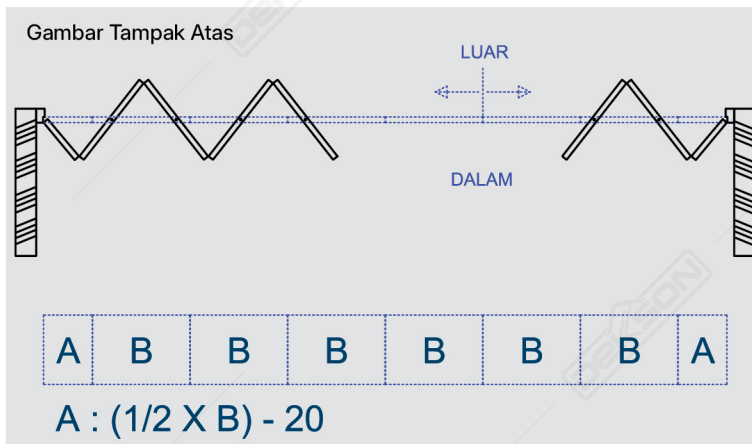

Gambar Tampak Depan

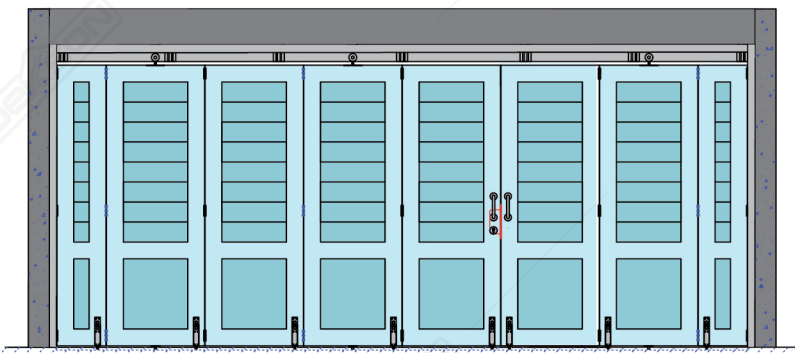

**Spesifikasi**

Maksimum tinggi pintu : 2400 mm  
 Maksimum berat pintu : 80 & 100 kg/daun pintu  
 Tebal pintu : 40 - 50 mm

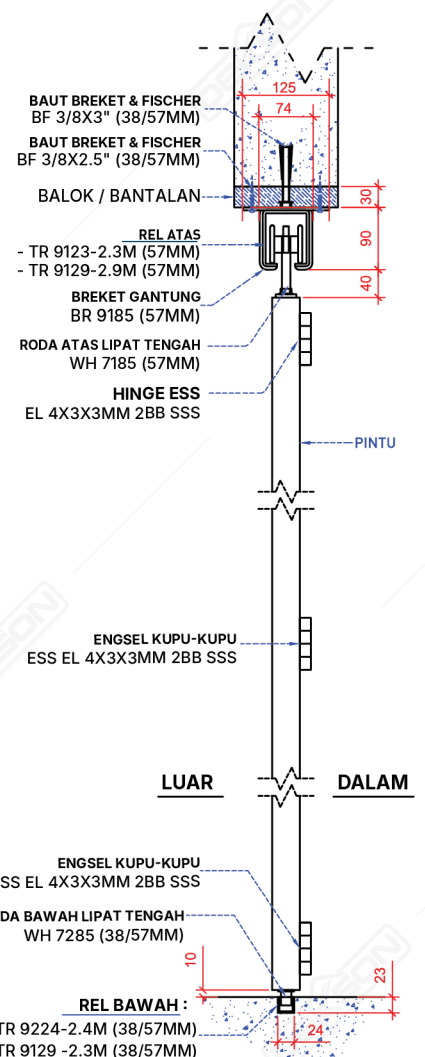

# PINTU DORONG LIPAT PINGGIR INTERIOR



① RODA ATAS LIPAT PINGGIR



WH 7186 (57MM) GALV

② RODA ATAS LIPAT PINGGIR "RD4"

Digunakan sebagai alternatif apabila maksimum berat daun pintu 100 kg



WH 7174 - RD4 (57MM) GALV

③ ENGSEL KUPU - KUPU



ESS EL 4X3X3MM 2BB SSS

④ GRENDDEL TANAM PLAT



FBP 8" SSS

⑤ REL ATAS



TR 9123 - 2.3M (57MM) GALV  
TR 9129 - 2.9M (57MM) GALV

⑥ REL BAWAH



TR 9224 - 2.4M (38/57MM) GALV  
TR 9230 - 3M (38/57MM) GALV

⑦ BREKET GANTUNG



BR 9185 (57MM) GALV

⑧ PULL HANDLE



PH D855 19x195x152 SSS

⑨ MORTISE ROLLER



MTS RL DL 8585 SSS

⑩ DOUBLE CYLINDER



CYL DC DL 60 MM SN

⑪ ESCUTCHEON



ESCN 855 SSS

⑫ RODA BAWAH LIPAT PINGGIR



WH 7286 (38/57MM) GALV

⑬ BAUT BREKET & FISHER



BF 3/8x2,5" (38/57MM) GALV  
BF 3/8x3" (38/57MM) GALV



Gambar Tampak Depan

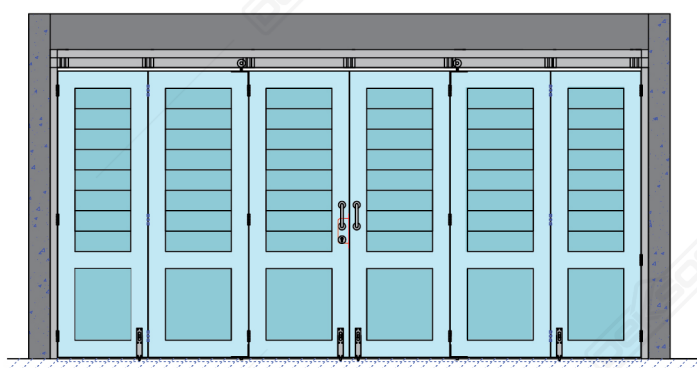

Gambar Tampak Atas

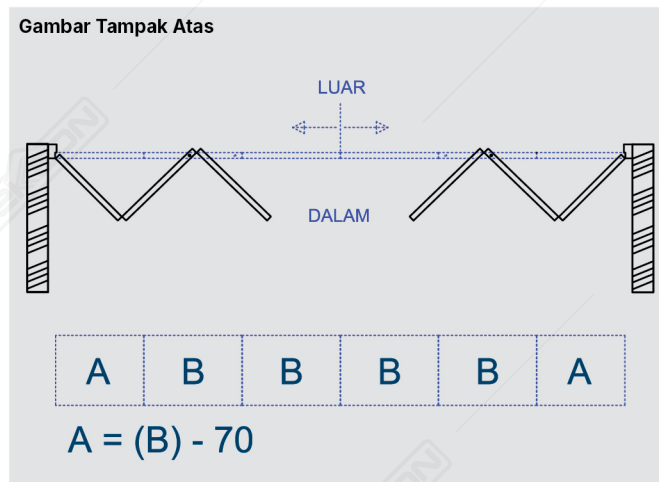

**Spesifikasi**

- Maksimum tinggi pintu : 2400 mm
- Maksimum berat pintu : 80 & 100 kg/daun pintu
- Tebal pintu : 40 - 50 mm

Gambar Potongan

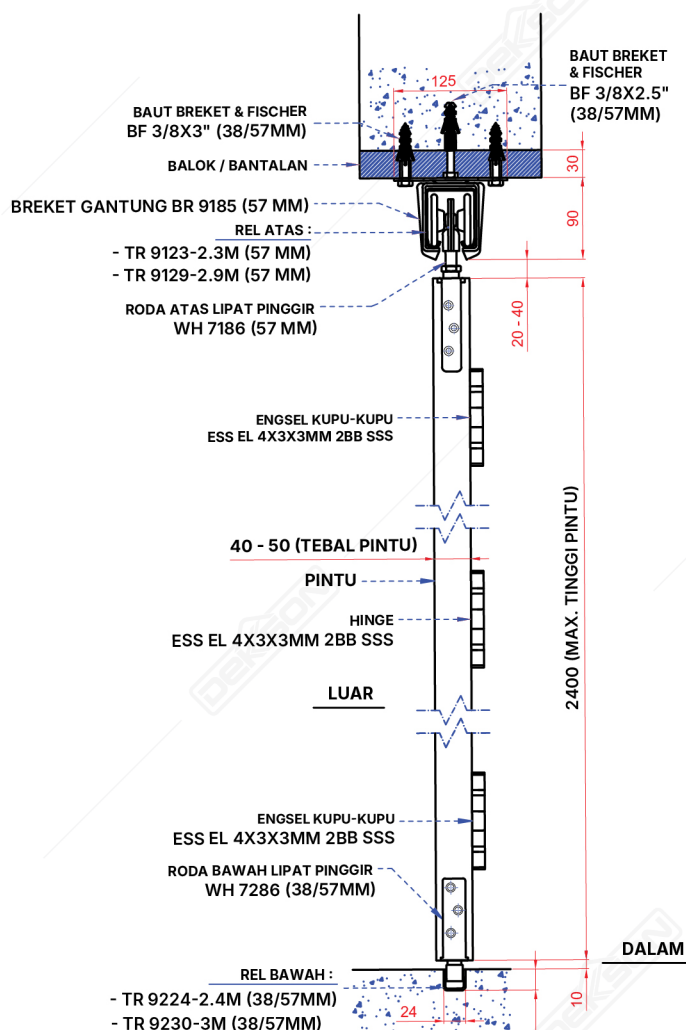

# INDEKS AKSESORIS PINTU DORONG

(untuk ukuran 80 Kg)



## RODA ATAS LIPAT PINGGIR

Kode Barang : WH 7186 (57MM) GALV  
Kode Komputer : 1601571961



## RODA ATAS LIPAT PINGGIR RD4

Kode Barang : WH 7174 - RD 4 (57MM) GALV  
Kode Komputer : 1601571741



## RODA ATAS LIPAT TENGAH

Kode Barang : WH 7185 (57MM) GALV  
Kode Komputer : 1601571851



## RODA ATAS LIPAT TENGAH RD4

Kode Barang : WH 7184 - RD 4 (57MM) GALV  
Kode Komputer : 1601571841



## RODA ATAS TENGAH

Kode Barang : WH 9105 (57MM) GALV  
Kode Komputer : 1601591051



## RODA ATAS TENGAH RD4

Kode Barang : WH 8144 - RD 4 (57MM) GALV  
Kode Komputer : 1601581441



## RODA ATAS TENGAH "L"

Kode Barang : WH 8195 - L (57MM) GALV  
Kode Komputer : 1601581951



## RODA ATAS PINGGIR "L"

Kode Barang : WH 8196 - L (57MM) GALV  
Kode Komputer : 1601581961



## RODA ATAS PINGGIR

Kode Barang : WH 9106 (57MM) GALV  
Kode Komputer : 1601591061

# INDEKS AKSESORIS PINTU DORONG

(untuk ukuran 80 Kg)

**10 YEARS**  
MECHANICAL  
WARRANTY



## RODA BAWAH LIPAT PINGGIR

Kode Barang : WH 7286 (38/57MM) GALV  
Kode Komputer : 1601572861



## RODA BAWAH LIPAT TENGAH

Kode Barang : WH 7285 (38/57MM) GALV  
Kode Komputer : 1601572851



## RODA BAWAH TENGAH

Kode Barang : WH 8205 (57MM) GALV  
Kode Komputer : 1601582051



## RODA BAWAH PINGGIR

Kode Barang : WH 8206 (57MM) GALV  
Kode Komputer : 1601582061



## ENGSEL TENGAH

Kode Barang : HN 8306 (57MM) GALV  
Kode Komputer : 1601583061



## BREKET SAMPING

Kode Barang : BR 9100 (57MM) GALV  
Kode Komputer : 1601591001



## BREKET SAMBUNG

Kode Barang : BR 9101 (57MM) GALV  
Kode Komputer : 1601591011



## BREKET GANTUNG

Kode barang : BR 9185 (57MM) GALV  
Kode Komputer : 1601591851



## TUTUP BREKET & STOPPER

Kode Barang : BR 9102 (57MM) GALV  
Kode Komputer : 1601591021

# INDEKS AKSESORIS PINTU DORONG

(untuk ukuran 80 Kg)



## GRENDDEL ATAS DEKSON

Kode barang : BB 8104-UK 75CM (38/57MM) GALV  
Kode Komputer : 1601581041

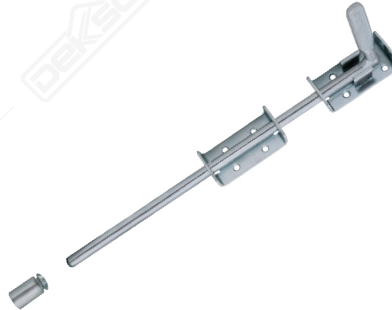

## GRENDDEL BAWAH BIASA

Kode barang : BB 9204 (38/57MM) GALV  
Kode Komputer : 1601592041



## GRENDDEL BAWAH BERODA

Kode barang : BB 8204 (38/57MM) GALV  
Kode Komputer : 1601582041



## REL ATAS

Kode Barang : TR 9123 - 2.3M (57MM) GALV  
Kode Komputer : 1601591231

Kode Barang : TR 9129 - 2.9M (57MM) GALV  
Kode Komputer : 1601591291



## REL BAWAH

Kode Barang : TR 9224 - 2.4M (38/57MM) GALV  
Kode Komputer : 1601592241

Kode Barang : TR 9230 - 3M (38/57MM) GALV  
Kode Komputer : 1601592301

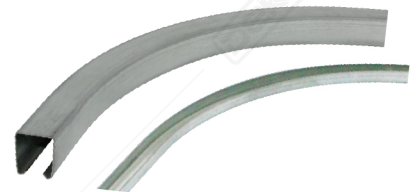

## REL TIKUNG ATAS & BAWAH

Kode Barang : TR 9190 (57MM) GALV  
Kode Komputer : 1601591901



## MORTISE SLIDING

Kode Barang : MTS SLD DL 84100 N  
Kode Komputer : 201121521

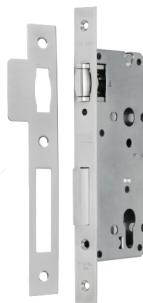

## MORTISE ROLLER

Kode Barang : MTS RL DL 8585 SSS  
Kode Komputer : 201121521



## ENGSEL KUPU - KUPU

Kode Barang : ES EL 4x3x3MM 2BB SSS  
Kode Komputer : 101131321

# INDEKS AKSESORIS PINTU DORONG

(untuk ukuran 80 Kg)



## ESCUTCHEON

Kode Barang : ESCN 855 SSS  
Kode Komputer : 901108551



## DOUBLE CYLINDER

Kode Barang : CYL DC DL 60MM SN  
Kode Komputer : 301211601



## PULL HANDLE

Kode Barang : PH D855 19×195×152 SSS  
Kode Komputer : 801180051



## GRENDEL TANAM PLAT

Kode Barang : FBP 8" SSS  
Kode Komputer : 1701054501



## BAUT BREKET & FISHER

Kode Barang : BF 3/8×2.5" (38/57 MM) GALV  
Kode Komputer : 1601538251

Kode Barang : BF 3/8×3" (38/57 MM) GALV  
Kode Komputer : 1601538351

Kode Barang : BF 3/8×4" (38/57 MM) GALV  
Kode Komputer : 1601538451

# SLIDE AND FOLD DOOR



# Table of Contents :

## ACCESSORIES FOR SLIDE & FOLD DOOR CONTENT (60 Kg)

### Pintu Dorong Lipat Eksterior Roda "STANDARD"

**19**

- Skema Pintu Dorong
- Gambar Tampak, Gambar Potongan, dan Gambar Denah

### Pintu Dorong Lipat Eksterior Roda "L"

**21**

- Skema Pintu Dorong
- Gambar Tampak, Gambar Potongan, dan Gambar Denah

### Pintu Dorong Menikung Eksterior Roda "STANDARD"

**23**

- Skema Pintu Dorong
- Gambar Tampak, Gambar Potongan, dan Gambar Denah

### Pintu Dorong Lipat Tengah Interior

**25**

- Skema Pintu Dorong
- Gambar Tampak, Gambar Potongan, dan Gambar Denah

### Pintu Dorong Lipat Pinggir Interior

**27**

- Skema Pintu Dorong
- Gambar Tampak, Gambar Potongan, dan Gambar Denah

### Indeks Aksesories Pintu Dorong Lipat

**29**

- Skema Pintu Dorong
- Gambar Tampak, Gambar Potongan, dan Gambar Denah

# PINTU DORONG LIPAT EKSTERIOR

RODA "STANDARD"



① RODA ATAS TENGAH



WH 39105 (38 MM)  
GALV

② RODA ATAS PINGGIR



WH 39106 (38 MM)  
GALV

③ ENGSEL TENGAH



HN 38306 (38 MM)  
GALV

④ RODA BAWAH TENGAH



WH 38205 (38 MM)  
GALV

⑤ RODA BAWAH PINGGIR



WH 38206 (38 MM)  
GALV

⑥ ENGSEL KUPU - KUPU

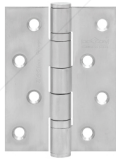

ESS EL 4X3X3MM 2BB SSS

⑦ GREDEL TANAM PLAT



FBP 8" SSS

⑧ GREDEL BAWAH BIASA

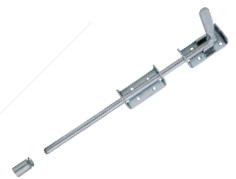

BB 9204 (38/57MM)  
GALV

⑨ REL ATAS DEKSON



TR 39123 - 2,3M (38 MM) GALV  
TR 39129 - 2,9M (38 MM) GALV

⑩ REL BAWAH DEKSON



TR 9224 - 2,4M (38/57MM) GALV  
TR 9230 - 3M (38/57MM) GALV

⑪ BREKET SAMPING



BR 39100 (38MM)  
GALV

⑫ PULL HANDLE



PH D855 19×195×152 SSS

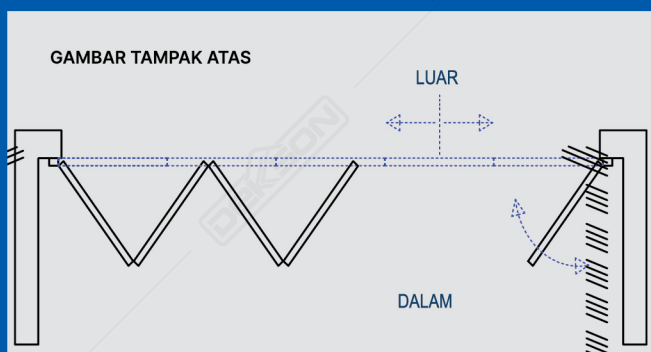
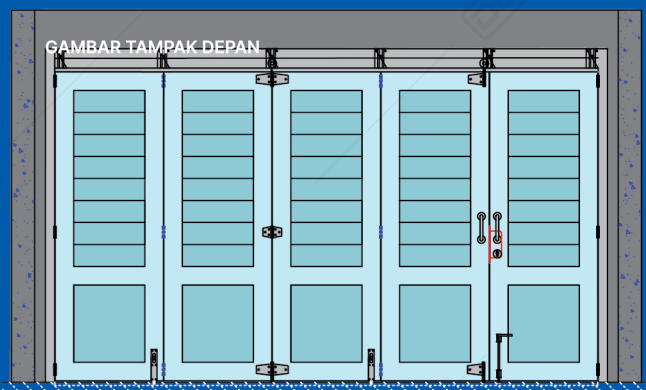
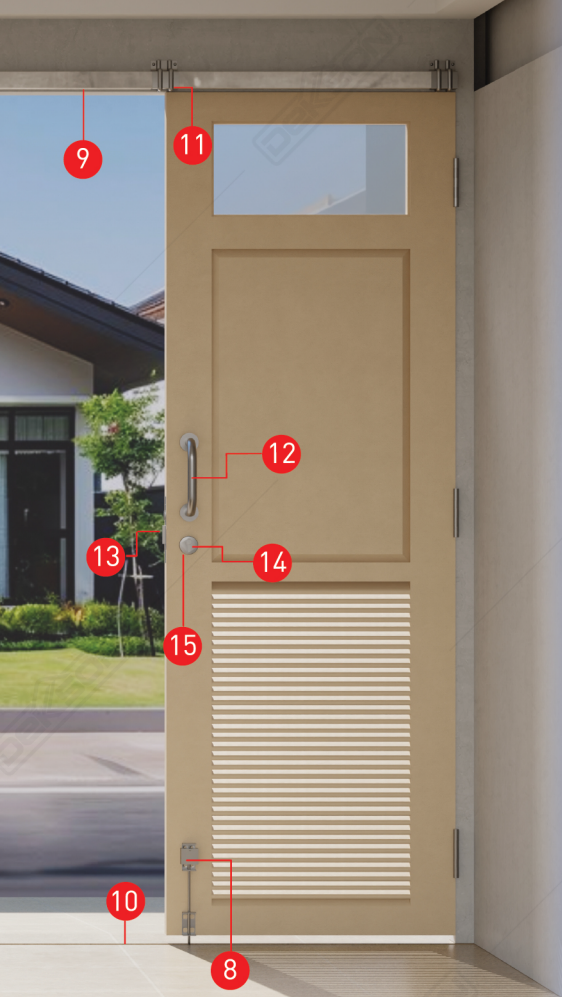

13 MORTISE ROLLER

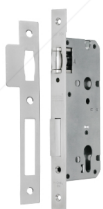

MTS RL DL 8585 SSS

15 ESCUTCHEON



ESCN 855 SSS

17 BAUT BREKET & FISHER DEKSON



BF 3/8x2,5" (38/57MM) GALV  
BF 3/8x3" (38/57MM) GALV

14 DOUBLE CYLINDER



CYL DC DL 60 MM SN

16 RODA ATAS TENGAH "RD4"

Digunakan sebagai alternatif apabila maksimum berat daun pintu 80 kg



WH 38144-RD 4  
(38 MM) GALV

Gambar Potongan

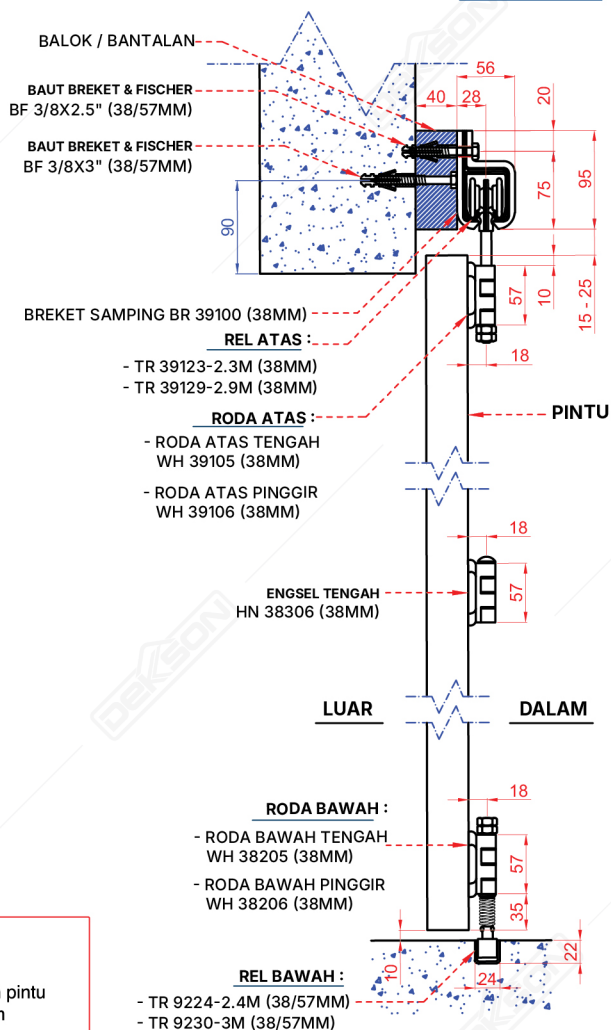

Spesifikasi

Maksimum tinggi pintu : 2400 mm  
Maksimum berat pintu : 60 kg/daun pintu  
Tebal pintu : 40 - 50 mm

# PINTU DORONG LIPAT EKSTERIOR

## RODA "RODA L"



① RODA ATAS TENGAH "L"



WH 38195-L (38 MM)  
GALV

② ENGSEL TENGAH



HN 38306 (38 MM)  
GALV

③ RODA BAWAH TENGAH



WH 38205 (38 MM)  
GALV

④ ENGSEL KUPU - KUPU



ESS EL 4X3X3MM 2BB SSS

⑤ GRENDEL TANAM PLAT



FBP 8" SSS

⑥ GRENDEL BAWAH BIASA

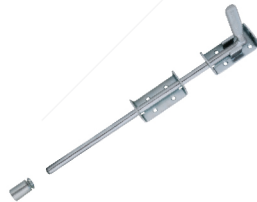

BB 9204 (38/57 MM)  
GALV

⑦ REL ATAS



TR 39123 - 2,3M (38 MM) GALV  
TR 39129 - 2,9M (38 MM) GALV

⑧ REL BAWAH 3M / 2,4 M



TR 9224 - 2.4M (38/57MM) GALV  
TR 9230 - 3M (38/57MM) GALV

⑨ BREKET SAMPING



BR 39100 (38MM)  
GALV

⑩ PULL HANDLE



PH D855 19×195×152 SSS

⑪ MORTISE ROLLER



MTS RL DL 8585 SSS

⑫ DOUBLE CYLINDER



CYL DC DL 60 MM SN



Gambar Tampak Depan

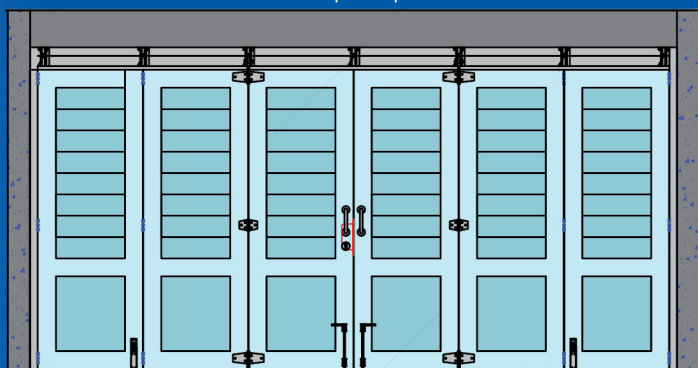

Gambar Tampak Atas

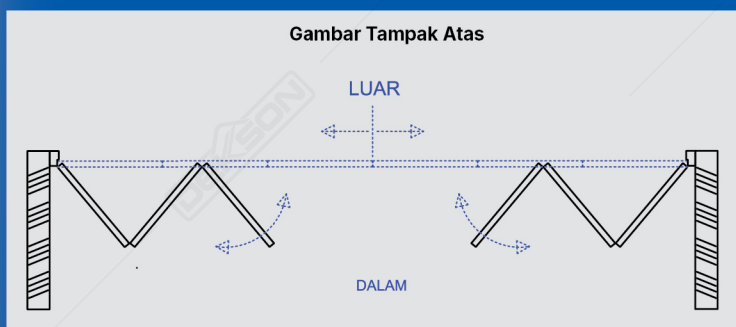

Gambar Potongan

13 ESCUTCHEON



ESCN 855 SSS

14 RODA ATAS PINGGIR "L"



WH 38196 - L (38 MM)  
GALV

15 RODA BAWAH PINGGIR



WH 38206 (38 MM)  
GALV

16 BAUT BREKET & FISHER



BF 3/8x2,5" (38/57MM) GALV  
BF 3/8x3" (38/57MM) GALV

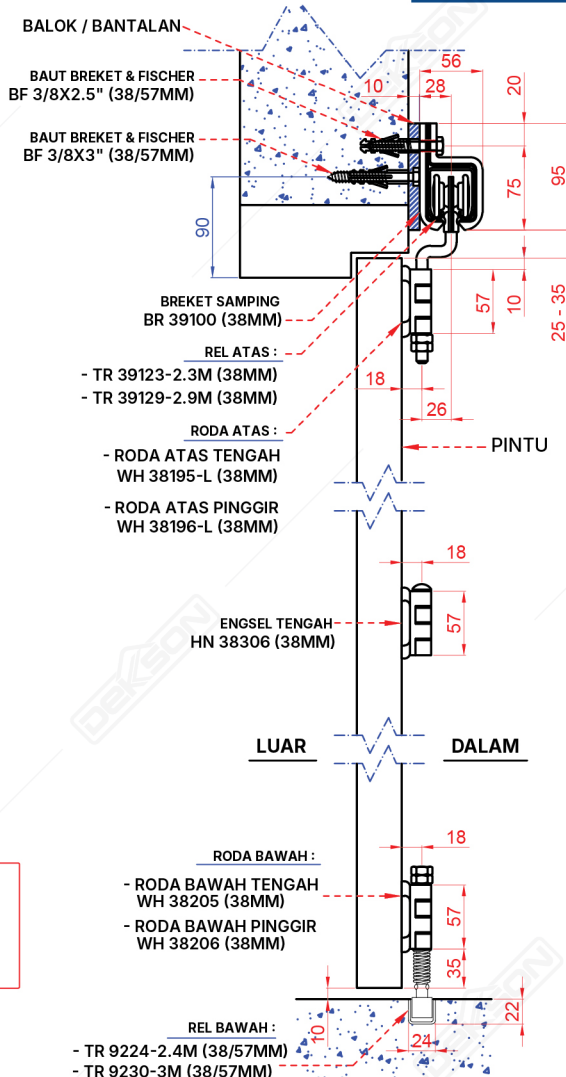

**Spesifikasi**

Maksimum tinggi pintu : 2400 mm  
Maksimum berat pintu : 60kg/daun pintu  
Tebal pintu : 40 - 50 mm

# PINTU DORONG MENIKUNG EKSTERIOR

## RODA "STANDARD"

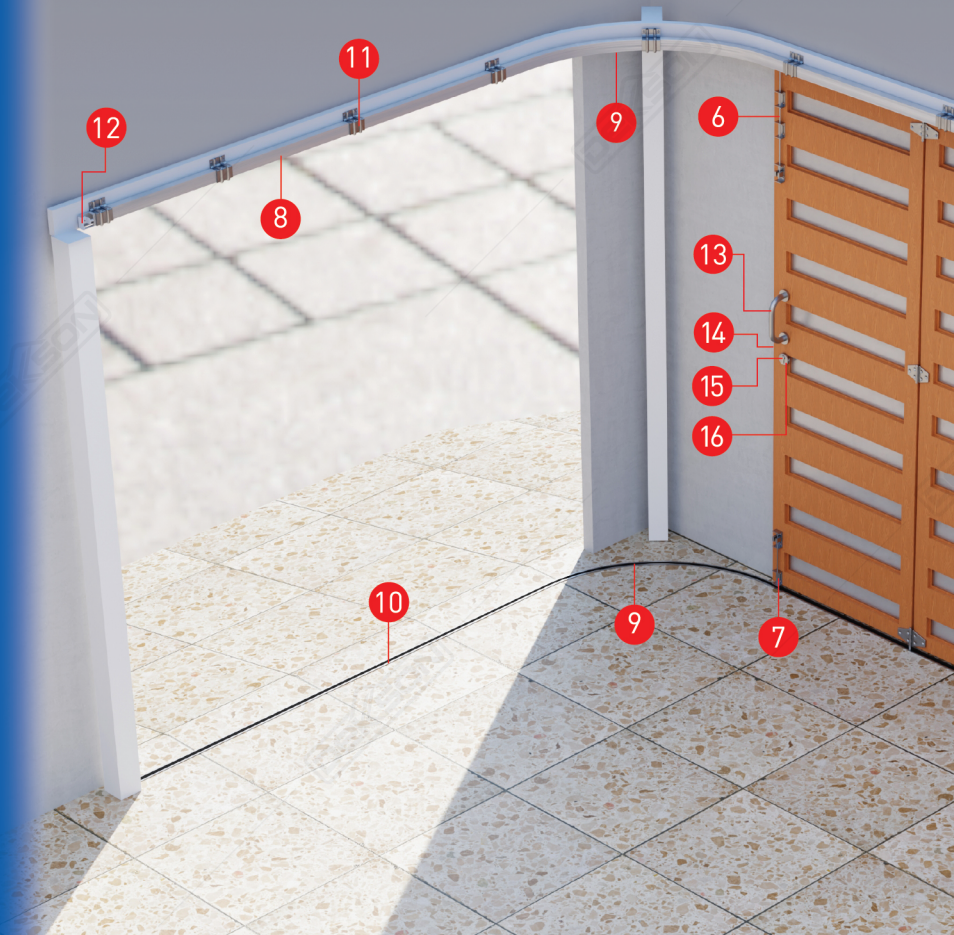

① RODA ATAS TENGAH



WH 39105 (38 MM) GALV

② RODA ATAS PINGGIR



WH 39106 (38 MM) GALV

③ ENGSEL TENGAH



HN 38306 (38 MM) GALV

④ RODA BAWAH TENGAH



WH 38205 (38 MM) GALV

⑤ RODA BAWAH PINGGIR



WH 38206 (38 MM) GALV

⑥ GREDEL ATAS



BB 8104 (38/57MM) GALV

⑦ GREDEL BAWAH BERODA



BB 8204 (38/57 MM) GALV

⑧ REL ATAS DEKSON



TR 39123 - 2,3M (38 MM) GALV  
TR 39129 - 2,9M (38 MM) GALV

⑨ REL TIKUNG ATAS & BAWAH

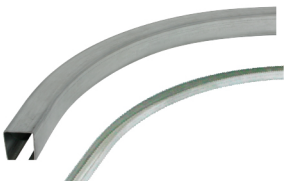

TR 39190 (38 MM) GALV

⑩ REL BAWAH DEKSON



TR 9224 - 2.4M (38/57MM) GALV  
TR 9230 - 3M (38/57MM) GALV

⑪ BREKET SAMPING



BR 39100 (38 MM) GALV

⑫ TUTUP BREKET & STOPPER



BR 39102 (38MM) GALV

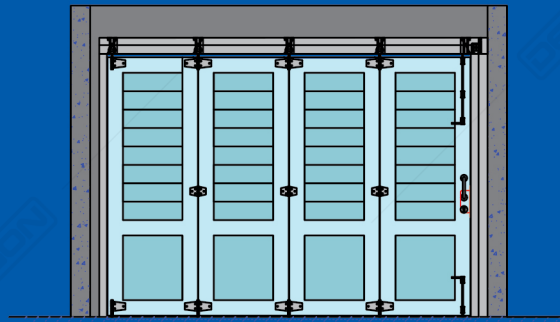

Gambar Tampak Atas

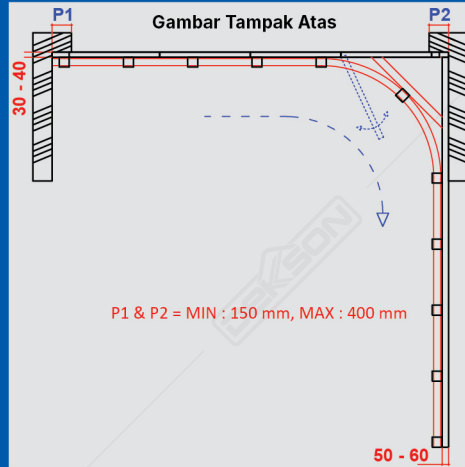

Gambar Potongan

13 PULL HANDLE



PH D855 19x195x152 SSS

14 MORTISE SLIDING



MTS SLD DL 84100 N SSS

15 DOUBLE CYLINDER



CYL DC DL 60 MM SN

16 ESCUTCHEON



ESCN 855 SSS

17 BAUT BREKET & FISHER DEKSON



BF 3/8x2.5" (38/57MM) GALV  
BF 3/8x3" (38/57MM) GALV  
BF 3/8x4" (38/57MM) GALV

Spesifikasi

Maksimum tinggi pintu : 2400 mm  
Maksimum berat pintu : 60 kg/daun pintu  
Maksimum lebar pintu : 500 mm  
Tebal pintu : 40 - 50 mm

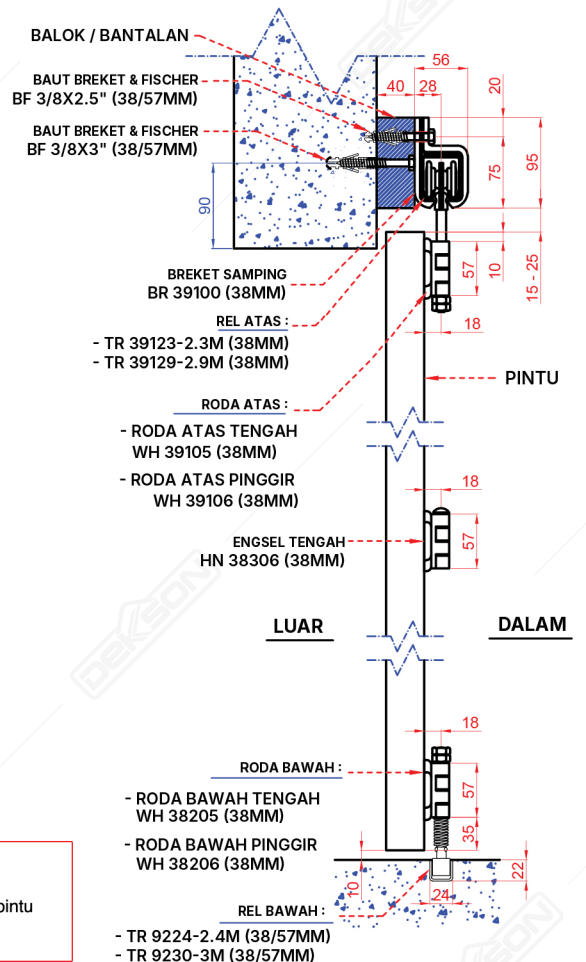

# PINTU DORONG LIPAT TENGAH INTERIOR



① RODA ATAS LIPAT TENGAH



WH 37185 (38 MM)  
GALV

② RODA ATAS LIPAT TENGAH "RD4"

Digunakan sebagai alternatif apabila maksimum berat daun pintu 80 kg



WH 37184-RD 4 (38 MM)  
GALV

③ ENGSEL KUPU - KUPU



ESS EL 4X3X3MM 2BB SSS

④ GRENDDEL TANAM PLAT



FBP 8" SSS

⑤ REL ATAS DEKSON



TR 39123 - 2,3M (38 MM) GALV  
TR 39129 - 2,9M (38 MM) GALV

⑥ REL BAWAH DEKSON



TR 9224 - 2.4M (38/57MM) GALV  
TR 9230 - 3M (38/57MM) GALV

⑦ BREKET GANTUNG



BR 39185 (38MM)  
GALV

⑧ PULL HANDLE



PH D855 19×195×152 SSS

⑨ MORTISE ROLLER

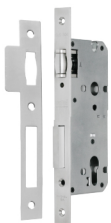

MTS RL DL 8585 SSS

⑩ DOUBLE CYLINDER



CYL DC DL 60 MM SN

⑪ ESCUTCHEON



ESCN 855 SSS

⑫ RODA BAWAH LIPAT TENGAH



WH 7285 (38/57MM)  
GALV

⑬ BAUT BREKET & FISHER DEKSON



BF 3/8×2,5" (38/57MM) GALV  
BF 3/8×3" (38/57MM) GALV

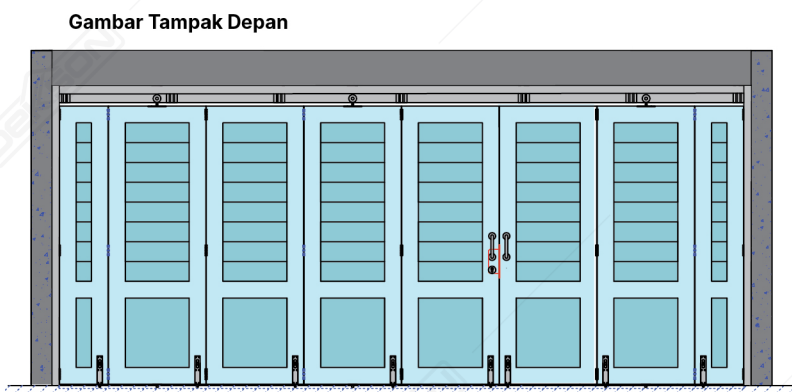
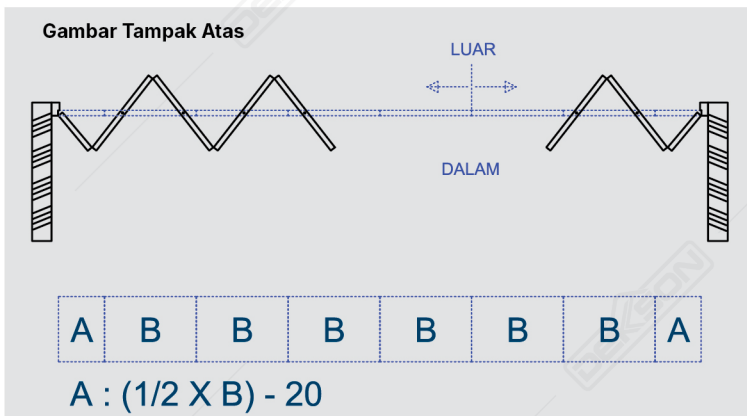

**Spesifikasi**

Maksimum tinggi pintu : 2400 mm  
 Maksimum berat pintu : 60 & 80 kg/daun pintu  
 Tebal pintu : 40 - 50 mm

**Gambar Potongan**

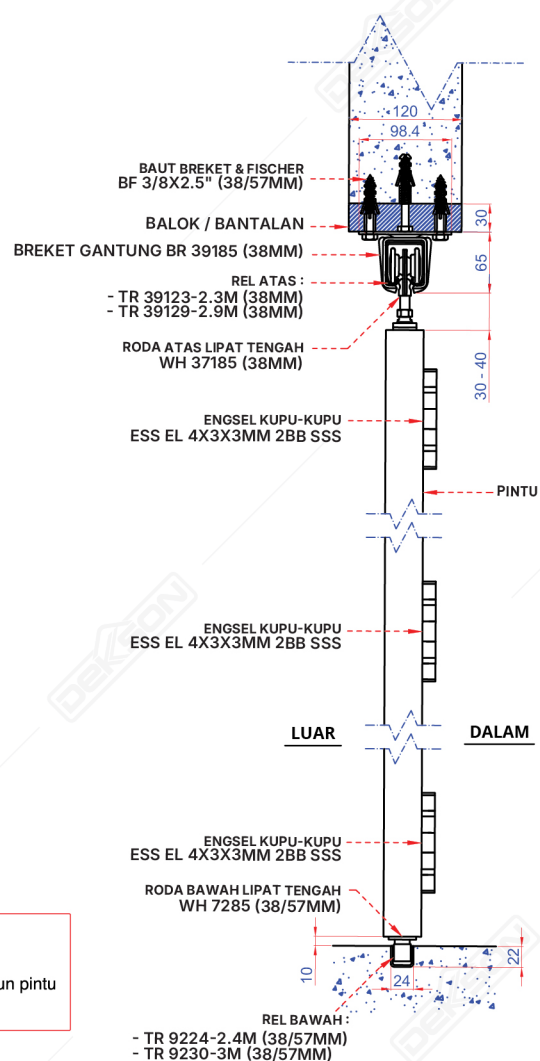

# PINTU DORONG LIPAT PINGGIR INTERIOR



① RODA ATAS LIPAT PINGGIR



WH 37186 (38 MM)  
GALV

② RODA ATAS LIPAT PINGGIR "RD4"

Digunakan sebagai alternatif apabila maksimum berat daun pintu 80 kg



WH 37174-RD 4 (38 MM)  
GALV

③ ENGSEL KUPU - KUPU



ESS EL 4X3X3MM 2BB SSS

④ GRENDEL TANAM PLAT



FBP 8'' SSS

⑤ REL ATAS DEKSON



TR 39123 - 2,3M (38 MM) GALV  
TR 39129 - 2,9M (38 MM) GALV

⑥ REL BAWAH DEKSON



TR 9224 - 2,4M (38/57MM) GALV  
TR 9230 - 3M (38/57MM) GALV

⑦ BREKET GANTUNG



BR 39185 (38MM)  
GALV

⑧ PULL HANDLE



PH D855 19×195×152 SSS

⑨ MORTISE ROLLER



MTS RL DL 8585 SSS

⑩ DOUBLE CYLINDER



CYL DC DL 60 MM SN

⑪ ESCUTCHEON



ESCN 855 SSS

⑫ RODA BAWAH LIPAT PINGGIR



WH 7286 (38/57MM)  
GALV

⑬ BAUT BREKET & FISHER DEKSON



BF 3/8×2,5'' (38/57MM) GALV  
BF 3/8×3' (38/57MM) GALV



Gambar Tampak Depan

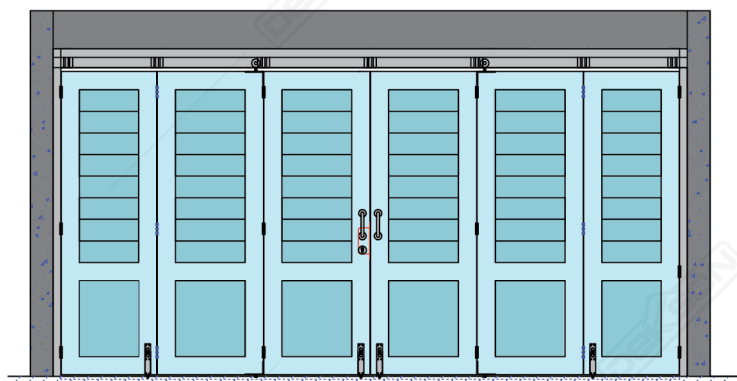

Gambar Tampak Atas

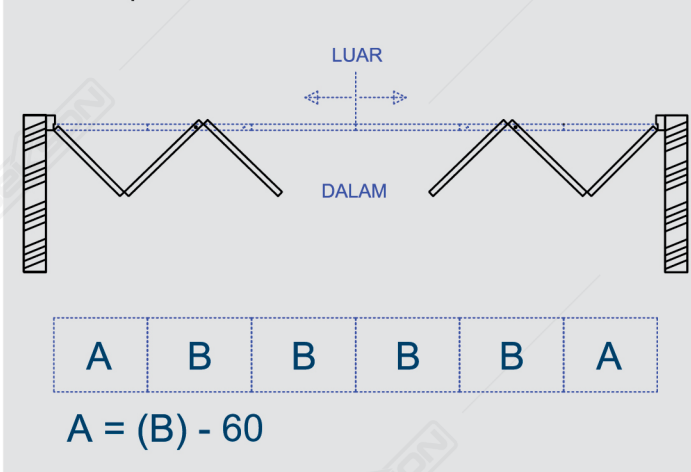

**Spesifikasi**

Maksimum tinggi pintu : 2400 mm  
 Maksimum berat pintu : 60 & 80kg/daun pintu  
 Tebal pintu : 40 - 50 mm

Gambar Potongan

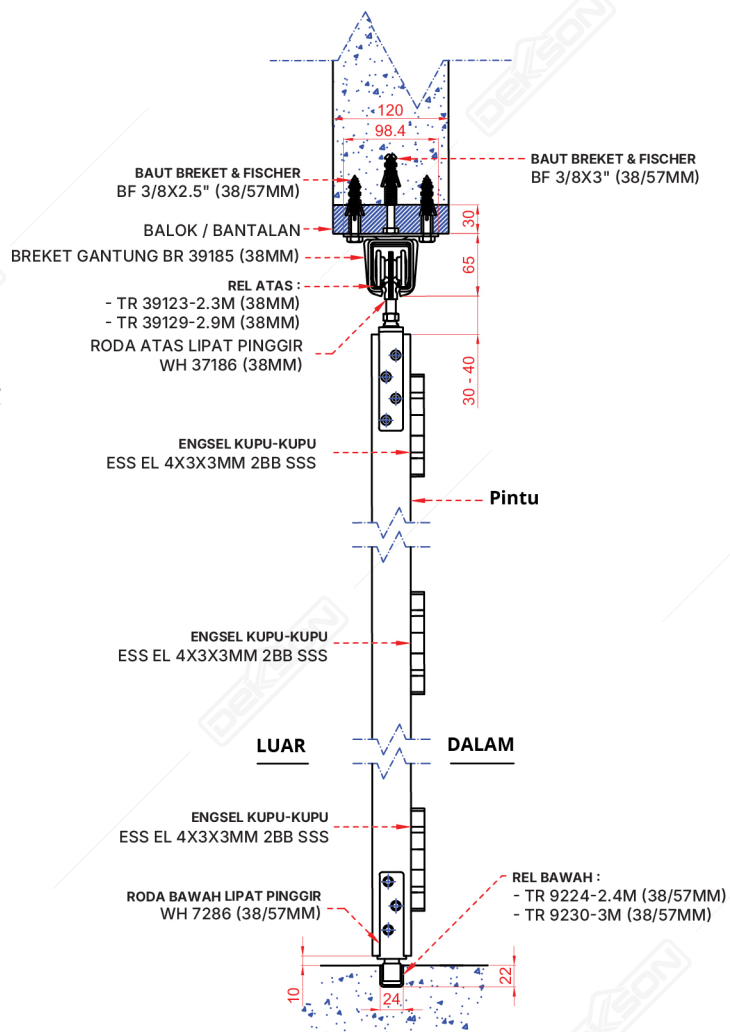

# INDEKS AKSESORIS PINTU DORONG

(untuk ukuran 60 Kg)



## RODA ATAS LIPAT PINGGIR

Kode Barang : WH 37186 (38MM) GALV  
Kode Komputer : 1601537161



## RODA ATAS LIPAT PINGGIR RD4

Kode Barang : WH 37174 - RD 4 (38MM) GALV  
Kode Komputer : 1601537171



## RODA ATAS LIPAT TENGAH

Kode Barang : WH 37185 (38MM) GALV  
Kode Komputer : 1601537151



## RODA ATAS LIPAT TENGAH RD4

Kode Barang : WH 37184 - RD 4 (38MM) GALV  
Kode Komputer : 1601537181



## RODA ATAS TENGAH

Kode Barang : WH 39105 (38MM) GALV  
Kode Komputer : 1601539151



## RODA ATAS TENGAH RD4

Kode Barang : WH 38144 - RD 4 (38MM) GALV  
Kode Komputer : 1601538141



## RODA ATAS TENGAH "L"

Kode Barang : WH 38195 - L (38MM) GALV  
Kode Komputer : 1601538191



## RODA ATAS PINGGIR "L"

Kode Barang : WH 38196 - L (38MM) GALV  
Kode Komputer : 1601538161



## RODA ATAS PINGGIR

Kode Barang : WH 39106 (38MM) GALV  
Kode Komputer : 1601539101



## RODA BAWAH LIPAT PINGGIR

Kode Barang : WH 7286 (38/57MM) GALV  
Kode Komputer : 1601572871



## RODA BAWAH LIPAT TENGAH

Kode Barang : WH 7285 (38/57MM) GALV  
Kode Komputer : 1601572851



## RODA BAWAH TENGAH

Kode Barang : WH 38205 (38MM) GALV  
Kode Komputer : 1601538201



## RODA BAWAH PINGGIR

Kode Barang : WH 38206 (38MM) GALV  
Kode Komputer : 1601538261



## ENGSEL TENGAH

Kode Barang : HN 38306 (38MM) GALV  
Kode Komputer : 1601538301



## BREKET SAMPING

Kode Barang : BR 39100 (38MM) GALV  
Kode Komputer : 1601539001



## BREKET GANTUNG

Kode Barang : BR 39185 (38MM) GALV  
Kode Komputer : 1601539181

# INDEKS AKSESORIS PINTU DORONG

(untuk ukuran 60 Kg)



## DOUBLE CYLINDER

Kode Barang : CYL DC DL 60MM SN  
Kode Komputer : 301211601



## GRENDEL ATAS

Kode Barang : BB 8104-UK 75CM  
(38/57MM) GALV  
Kode Komputer : 11601581041

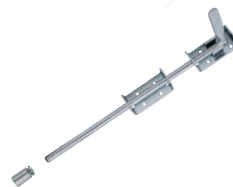

## GRENDEL BAWAH BIASA

Kode Barang : BB 9204 (38/57MM)  
GALV  
Kode Komputer : 1601592041



## GRENDEL BAWAH BERODA

Kode Barang : BB 8204 (38/57MM)  
GALV  
Kode Komputer : 1601582041



## REL ATAS

Kode Barang : TR 39123 - 2.3M  
(38 MM) GALV  
Kode Komputer : 1601539121  
Kode Barang : TR 39129 - 2.9M  
(38 MM) GALV  
Kode Komputer : 1601539191



## REL BAWAH

Kode Barang : TR 9224 - 2.4M  
(38/57 MM) GALV  
Kode Komputer : 1601592241  
Kode Barang : TR 9230 - 3M  
(38/57MM) GALV  
Kode Komputer : 161592301

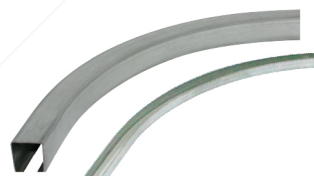

## REL TIKUNG ATAS & BAWAH

Kode Barang : TR 39190 R60 (38 MM) GALV  
Kode Komputer : 1601539601



## GRENDEL TANAM PLAT

Kode Barang : FBP 8" SSS  
Kode Komputer : 1701054501

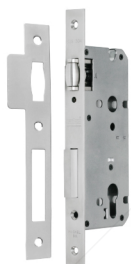

## MORTISE ROLLER

Kode Barang : MTS RL DL 8585 SSS  
Kode Komputer : 201121521

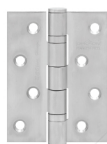

## ENGSEL KUPU-KUPU

Kode Barang : ES EL 4×3×3MM 2BB SSS  
Kode Komputer : 101131321



## MORTISE SLIDING

Kode Barang : MTS SLD DL 84100 N  
Kode Komputer : 201121521



## PULL HANDLE DEKSON

Kode Barang : PH D855  
19×195×152 SSS  
Kode Komputer : 801180051



## ESCUTCHEON

Kode Barang : ESCN 855 SSS  
Kode Komputer : 901108551



## BAUT BREKET & FISHER

Kode Barang : BF 3/8×2.5" (38/57 MM) GALV  
Kode Komputer : 1601538251  
Kode Barang : BF 3/8×3" (38/57 MM) GALV  
Kode Komputer : 1601538351  
Kode Barang : BF 3/8×4" (38/57 MM) GALV  
Kode Komputer : 1601538451



AVAILABLE AT :

